



Sovitron Interior Pvt.Ltd.



Model Name

SILAS-WL4 Wall Light/ DL-OMT-15302-10

Description

Wall light (Direct-Indirect)

Technical description

Image

Dimension

Dia=150mm
H=150mm

Frame

Aluminium Die-cast

Color Tempertaure

4000K

Power

2x5W

Total Luminous Flux

800 lm

Efficacy

80 lm/W

IP rating

65

Beam angle

12/24/36/60 Degree

Color Rendering

≥80

Mounting

Surface

Optics

Glass Lens

Dimming

NON-Dimmable

Operating Voltage

220-240 VAC

Standard Lifetime

L70 minimum at 50,000
burning hours



Dimension diagram

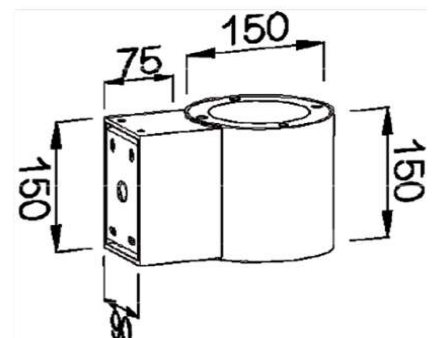

Remarks:-

Address: Plot #7 Saroorpur-Nangla Industrial Area, Ballabgarh-Sohna Road, Faridabad-121005

Email: info@sovitron.com